



Only the most professional specialty hearth retailers are selected to sell Lopi stoves, inserts and fireplaces. They represent our total commitment to exceptional products and excellent service. In addition, they have successfully completed special training programs in the proper selection, installation, and service of all Lopi products.

Your professional Lopi hearth dealers are experts who can advise you on everything from customizing the color of your appliance to selecting appropriate venting and chimney materials. They can show you Lopi models on display, including working models actually burning.



Lopi produces a wide variety of quality wood, pellet, gas and electric hearth appliances.

Find your favorite fire today by visiting:

www.lopistoves.com.

Your Lopi Authorized Dealer:



LOPI PRODUCTS
ARE MADE WITH PRIDE
IN THE U.S.A.



©2010/08 Printed in U.S.A. - #98800200
Lopi reserves the right to alter or improve its products at any time without notification.
All trademarks belong to Travis Industries.



WOOD STOVES & FIREPLACE INSERTS



WOOD HEAT IS GOOD HEAT!

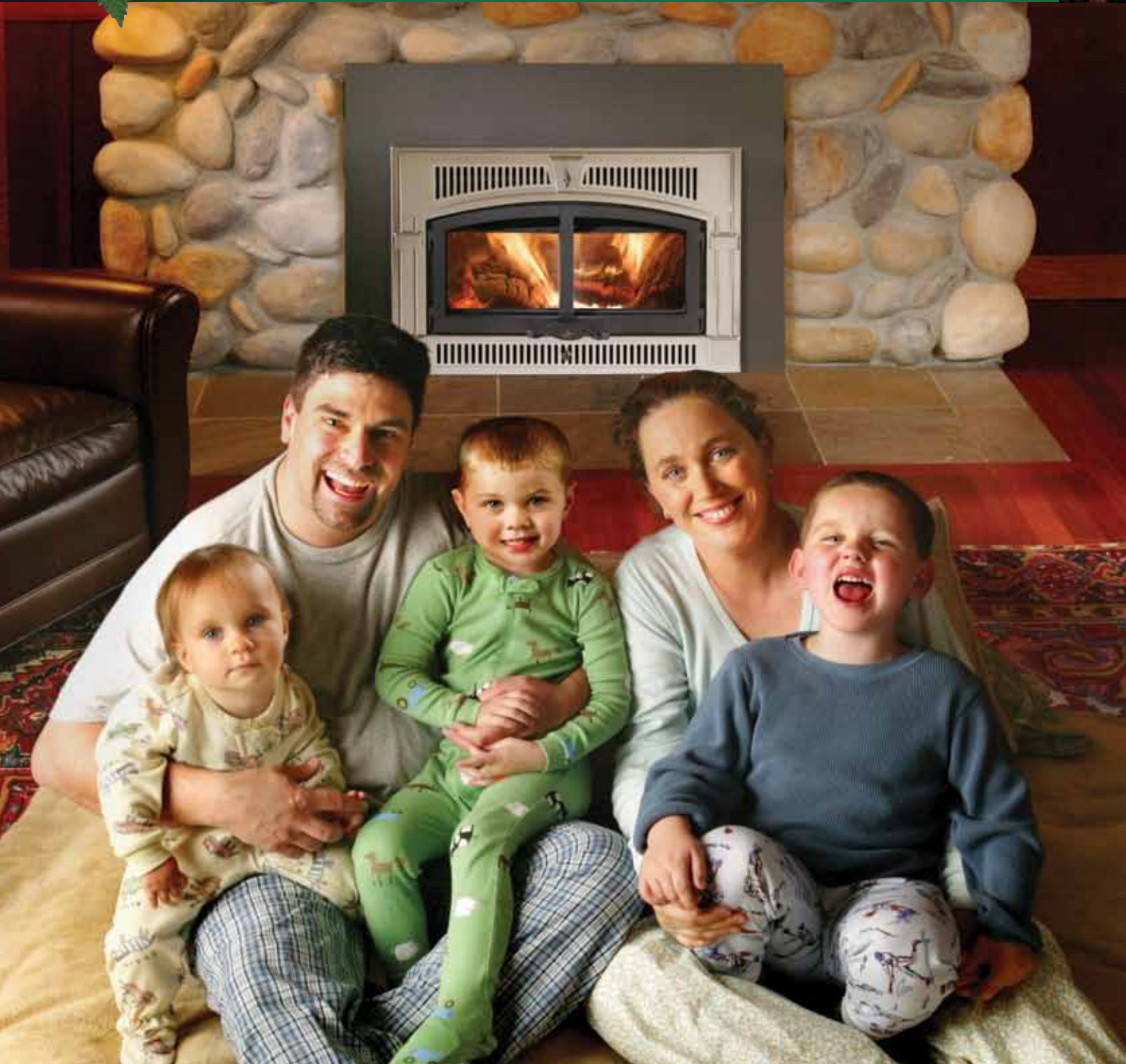

**GET UP
TO A**

\$1,500 TAX CREDIT

The USA Federal Bio-Mass Tax Credit Expires Dec. 31st, 2010





AMERICA'S FAVORITE FIRE

1



1979 - First Lopi Stove

Lopi wood stoves and inserts have been America's favorite choice in fire for over thirty years. Our reputation for solid craftsmanship, reliable performance and unbeatable heating efficiency has been a winning combination year after year, and the favorite fire of families across the nation.

Lopi heating appliances are designed and hand-assembled at our state-of-the-art plant in Mukilteo, Washington. Each stove comes with our seven year warranty. After all, we have the experience and confidence to stand behind every single product we make, so we put it in writing. We've learned and grown with every stove we've built over the years but one thing that hasn't changed is the beauty of our stoves and inserts, performance you can trust and our commitment to your satisfaction.

Whether you are new to the family of Lopi heating appliances or already a part of our family, we invite you to take a look at our newest line of wood stoves and inserts. We know you'll find your favorite fire.

WHY HEAT WITH WOOD?

Nothing heats like wood. Lopi wood stoves and fireplace inserts warm the coldest days, brighten the darkest nights and fill your home with the gentle, radiant heat only wood can produce. With styles and installation choices for every room in your home, America's favorite fire helps you declare yourself free from high heating bills.

WOOD HEAT IS GOOD HEAT!

All wood stoves manufactured by Lopi are certified by the EPA and are designed to emit only a fraction of the smoke that older, non-certified stoves produced. Burning wood emits no more carbon dioxide into the environment than would normally be produced from the same wood if left to decay in the forest. You can feel confident to know that burning wood is truly Carbon Neutral to the environment and a responsible and sustainable way to heat your home.

HOW DO YOU SAY LOPI?

We hear a lot of different pronunciations - Lopey...Loopee...Loppy! It's actually pronounced Low-pie, and was created by our president, Kurt Rumens. The name was inspired by a love of the Northwest, a fascination with Native American culture and the nature and wildlife that live in this beautiful place. Lopi means beauty, strength and independence and has become a legend all its own.



Lopi is not so much a brand name as it is a tradition — of craftsmanship in the construction of our wood stoves and of pride to the families who own them. We invite you to share this proud tradition.

KURT W. F. RUMENS
President, Travis Industries

WHY BUY A LOPI WOOD STOVE?



ENERGY INDEPENDENCE

The expense of heating your home with oil, gas or electricity just keeps going up. Lopi's radiant and convective wood stoves give you even, penetrating heat that comfortably warms every room in your home for a fraction of what you'd pay for standard utilities.

CARE FOR THE ENVIRONMENT



Did you know an old, inefficient wood stove can generate as much as three pounds of pollutants into the air each day? Lopi stoves are E.P. A. certified and emit as little as 1.9 grams of particulates per hour, thus reducing pollutants by over 95 percent. By using a Lopi stove, you're keeping the air in your neighborhood clean and breathable. And because wood is a renewable resource, Lopi stoves are so efficient they use substantially less wood than other stoves to get the same amount of heat output. All Lopi wood stoves have the option of adding an Outside Air Kit, which allows the stove to pull combustion air from outside rather than from inside the home. This prevents the stove from pulling in and removing the already heated room air for combustion and protects your indoor air quality.

BUILT TO PERFORM, BUILT TO LAST

Lopi offers the choice of the mid-priced Republic line of freestanding radiant wood stoves and the high performance Classic line-up of Lopi wood stoves that includes a high performance convection chamber as a standard feature and are the only non-catalytic stoves to feature a standard bypass damper for smokeless startup and reloading. With heavy gauge steel construction, solid airtight doors and commercial grade firebrick, our stoves are built to last a lifetime.



Bypass Damper

NO POWER? NO PROBLEM!

Lopi wood stoves provide reliable heat even during power outages and don't need blowers to operate. So you'll be warm and cozy no matter what's going on outside. Many of our models have cooking surfaces so you can warm soup or cider or fry bacon and eggs for breakfast.

A WARMTH LIKE NO OTHER

Wood heat soothes and radiates and nothing does it better than a Lopi wood stove. Most stoves give off radiant heat that only warms objects within the room. Lopi's five-sided convection chamber system circulates air around the stove and then pushes the warm air through the room to other areas of your home. It's a difference you can feel.





REPUBLIC 1250

S T O V E

COOKTOP SURFACE

Available in
CANADA



3



Shown with black cast door and steel legs.

Now experience the performance and quality you've come to expect in Lopi wood stoves in two mid-priced economy models. Without compromising construction or function, Lopi has managed to produce the Republic wood stove line that's designed to be affordable, good looking and just plain heats.

The economically priced Republic™ 1250 is designed to heat smaller homes or for zonal heating specific areas or rooms. Features include large radiant heat transfer surfaces, fully lined ceramic brick firebox, heavy-duty steel construction, and the option of either steel legs or pedestal with outside air kit option. The Republic 1250 is also approved for Hearth Stove, Alcove and Mobile Home installations. Comes with a 5 year Real World Warranty.

Options: Choice of Steel Legs or Pedestal, Convection Fan, Outdoor Air Kit and Firescreen.

| Emissions | Heating Capacity | Heat Output | Maximum Burn Time | Firebox Size | Maximum Log Size | Weight | Construction | Efficiency |
|--------------------|----------------------|------------------------------|-------------------|----------------|------------------|-------------------------|---------------------------|-------------|
| 4.4 Grams Per Hour | 600 to 1,200 Sq. Ft. | Cord Wood 66,800 BTUs/Hr. | Up To 8 Hours | 1.6 Cubic Foot | Up To 18" | 243 lbs. (With Legs) | 1/4" to 3/16" Steel Plate | Up To 79.6% |

REPUBLIC 1750

S T O V E

COOKTOP SURFACE



Available in
CANADA



4

Shown with standard black door and pedestal option. Keep combustibles 36" from front of stove.

The Republic™ 1750 wood stove offers the classic Lopi look -- a radiant surface for cooking and a convection surface for warming. And it packs a powerful punch. Its ceramic brick lined firebox is larger than most small stoves. To get heat to the room, the Republic 1750 uses a rear and top convection chamber to enhance warm air circulation throughout your home. This provides more even heat than you get with a radiant-only wood stove. The economically priced Republic 1750 is ideal for mid-sized homes and for zonal heating specific areas of larger homes. The Republic 1750 is also approved for Hearth Stove, Alcove and Mobile Home installations. Comes with a 5 year Real World Warranty.

Options: Choice of Steel Legs or Pedestal, Convection Fan, Outdoor Air Kit and Firescreen.

| Emissions | Heating Capacity | Heat Output | Maximum Burn Time | Firebox Size | Maximum Log Size | Weight | Construction | Efficiency |
|--------------------|------------------------|------------------------------|-------------------|----------------|------------------|-------------------------|----------------------------|-------------|
| 1.9 Grams Per Hour | 1,200 to 2,000 Sq. Ft. | Cord Wood 72,400 BTUs/Hr. | Up To 10 Hours | 2.2 Cubic Foot | Up To 18" | 430 lbs. (With Legs) | 5/16" to 3/16" Steel Plate | Up To 78.8% |



ANSWER

S T O V E

5



Shown with sharp redwood paint and optional solid brass door and pedestal.

It may be small, but the compact Answer's size belies its incredible heating capacity. The Answer™ uses a five-sided convection chamber to distribute heat evenly throughout your home. Cool room air is naturally drawn around the hot firebox, heated, and returned back into the room without using a blower. The Answer's 1.6 cubic foot firebox is larger than most other small stoves, so it offers longer burn times with less reloading. It's a powerful heater for its size, yet backwall clearance allows the stove to be installed as close as 9" to a rear combustible. The Answer is also approved for Hearth Stove, Alcove and Mobile Home installations.

Options: Door finishes in Black, Brass or Pewter, Four Decorative Leg Designs, Pedestal, Convection Fan, Etched Glass, Outdoor Air Kit and Firescreen.

| Emissions | Heating Capacity | Heat Output | Maximum Burn Time | Firebox Size | Maximum Log Size | Weight | Construction | Efficiency |
|--------------------|----------------------|------------------------------|-------------------|----------------|------------------|-------------------------|-------------------------------|----------------|
| 4.4 Grams Per Hour | 750 to 1,400 Sq. Ft. | Cord Wood 66,800 BTUs/Hr. | 8 Hours | 1.6 Cubic Foot | 18" | 300 lbs. (With Legs) | 5/16" to 3/16" Steel Plate | Up To 79.6% |

ENDEAVOR

S T O V E

COOKTOP SURFACE



Available in
CANADA



6

Shown with a charcoal paint finish, optional black door and cast legs.

The Endeavor™ is a beautiful workhorse that unites form and function into an unbeatable heat transfer system. Its classic step-top design features a radiant surface for cooking, and a convection surface for warming. It has the biggest and cleanest-burning firebox of any medium-size stove, yet offers the closest clearance of any wood stove in the industry — as close as 4 1/4" inches to a rear combustible surface. The Endeavor also features a taller door opening than any other medium-size stove, allowing you to load bigger pieces of wood and produce longer burn times. In addition, a by-pass damper makes startup easy and prevents smoke-backs during reloading. The Endeavor is also approved for Hearth Stove, Alcove and Mobile Home installations. Comes with a 5 year Real World Warranty.

Options: Door finishes in Black, Brass or Pewter, Four Decorative Leg Designs, Pedestal, Convection Fan, Etched Glass, Outdoor Air Kit & Firescreen.

| Emissions | Heating Capacity | Heat Output | Maximum Burn Time | Firebox Size | Maximum Log Size | Weight | Construction | Efficiency |
|--------------------|------------------------|------------------------------|-------------------|----------------|------------------|-------------------------|----------------------------|-------------|
| 1.9 Grams Per Hour | 1,200 to 2,000 Sq. Ft. | Cord Wood 72,400 BTUs/Hr. | 10 Hours | 2.2 Cubic Foot | 18" | 448 lbs. (With Legs) | 5/16" to 3/16" Steel Plate | Up To 78.8% |



LIBERTY S T O V E

COOKTOP SURFACE

7



Shown with optional solid brass door, legs and customized with a metallic brown paint finish.

The Liberty™ is the largest stove made by Lopi. At only 2.6 grams of emissions per hour, it is also the cleanest-burning large stove ever approved by the EPA. The Liberty has the biggest firebox of any large stove, which accepts 24 inch logs. It also features a single control to adjust air flow, making it easy to achieve burn times up to 12 hours long. The Liberty's step-top design is enchanting yet functional, providing cooking and warming surfaces as well as radiant and convective heat. The viewing area is extra-large, allowing you to fully appreciate the splendor of the fire inside. The Liberty uses a 6" diameter flue, compared with the more expensive 8" flue required by other large wood stoves. The Liberty is also approved for Hearth Stove, Alcove and Mobile Home installations.

Options: Door finishes in Black, Brass or Pewter, Four Decorative Leg Designs, Pedestal, Convection Fan, Etched Glass, Outdoor Air Kit & Firescreen.

| Emissions | Heating Capacity | Heat Output | Maximum Burn Time | Firebox Size | Maximum Log Size | Weight | Construction | Efficiency |
|--------------------|------------------------|------------------------------|-------------------|----------------|------------------|-------------------------|-------------------------------|----------------|
| 2.6 Grams Per Hour | 1,500 to 2,500 Sq. Ft. | Cord Wood 74,300 BTUs/Hr. | 12 Hours | 3.1 Cubic Foot | 24" | 490 lbs. (With Legs) | 5/16" to 3/16" Steel Plate | Up To 76.9% |

LOPI WOOD STOVES



REPUBLIC 1250

REPUBLIC 1750

ANSWER

ENDEAVOR

LIBERTY

| | SMALL | | MEDIUM | | SMALL | | MEDIUM | | LARGE | |
|--------------------------------|-----------------------|-----------------------|-----------------------|-----------------------|-----------------------|-----------------------|-----------------------|-----------------------|-----------------------|-----------------------|
| SPECIFICATIONS | | | | | | | | | | |
| WIDTH | 23 3/8" | | 24" | | 23 3/8" | | 24" | | 30" | |
| HEIGHT (ALL LEGS) | 26 1/2" | | 26 1/2" | | 27 7/8" | | 30 3/8" | | 32 1/4" | |
| HEIGHT (PEDESTAL) | 30 3/8" | | 30 3/8" | | 31 7/8" | | 34 3/8" | | 36 1/4" | |
| DEPTH | 14 3/8" | | 23 1/2" | | 16 1/4" | | 23 1/2" | | 21" | |
| FLUE SIZE | 6" | | 6" | | 6" | | 6" | | 6" | |
| CONSTRUCTION (PLATE STEEL) | 1/4" TO 3/16" | | 5/16" TO 3/16" | | 5/16" TO 3/16" | | 5/16" TO 3/16" | | 5/16" TO 3/16" | |
| WEIGHT (BODY W/LEGS) | 243 LBS. | | 430 LBS. | | 300 LBS. | | 448 LBS. | | 490 LBS. | |
| PERFORMANCE | | | | | | | | | | |
| EMISSIONS | 4.4 GRAMS/HR. | | 1.9 GRAMS/HR. | | 4.4 GRAMS/HR. | | 1.9 GRAMS/HR. | | 2.6 GRAMS/HR. | |
| HEATING CAP. (SQ FT.) | 600 TO 1,200 | | 1,200 TO 2,000 | | 750 TO 1,400 | | 1,200 TO 2,000 | | 1,500 TO 2,500 | |
| HEAT OUTPUT | 66,800 BTU'S/HR. | | 72,400 BTU'S/HR. | | 66,800 BTU'S/HR. | | 72,400 BTU'S/HR. | | 74,300 BTU'S/HR. | |
| EFFICIENCY (DEQ) | UP TO 79.6% | | UP TO 78.8% | | UP TO 79.6% | | UP TO 78.8% | | UP TO 76.9% | |
| MAXIMUM BURN TIME | UP TO 8 HOURS | | UP TO 10 HOURS | | UP TO 8 HOURS | | UP TO 10 HOURS | | UP TO 12 HOURS | |
| FIREBOX SIZE | 1.6 CUBIC FT. | | 2.2 CUBIC FT. | | 1.6 CUBIC FT. | | 2.2 CUBIC FT. | | 3.1 CUBIC FT. | |
| MAXIMUM LOG SIZE | UP TO 18" | | UP TO 18" | | UP TO 18" | | UP TO 18" | | UP TO 24" | |
| CLEARANCES | | | | | | | | | | |
| | SINGLE WALL CONNECTOR | DOUBLE WALL CONNECTOR | SINGLE WALL CONNECTOR | DOUBLE WALL CONNECTOR | SINGLE WALL CONNECTOR | DOUBLE WALL CONNECTOR | SINGLE WALL CONNECTOR | DOUBLE WALL CONNECTOR | SINGLE WALL CONNECTOR | DOUBLE WALL CONNECTOR |
| A= STOVE TO SIDE WALL | 18" | 18" | 15" | 13" | 18" | 13" | 15" | 13" | 16" | 6" |
| B= STOVE TO BACK WALL | 18" | 10 1/2" | 15" | 4 1/4" | 16 1/2" | 9" | 15" | 4 1/4" | 15" | 10" |
| C= STOVE TO CORNER WALL | 10" | 10" | 15" | 6 1/2" | 10" | 7 1/2" | 15" | 6 1/2" | 9 1/2" | 7 1/2" |
| D= CONNECTOR TO SIDE WALL | 27" | 26 1/2" | 24" | 21 1/2" | 27" | 21 1/2" | 24" | 21 1/2" | 28" | 27 1/2" |
| E= CONNECTOR TO BACK WALL | 19 1/4" | 11 1/4" | 17 3/4" | 6 1/2" | 19 1/2" | 11 1/2" | 17 3/4" | 6 1/2" | 18 1/4" | 12 3/4" |
| F= CONNECTOR TO CORNER WALL | 17 3/4" | 17 1/4" | 24" | 15" | 19 1/2" | 16 1/2" | 24" | 15" | 21" | 18 1/2" |
| HEARTH PROTECTION | | | | | | | | | | |
| | USA | CANADA | USA | CANADA | | | USA | CANADA | | |
| G= FRONT | 16" | 18" | 16" | 18" | 16" | | 16" | 18" | 16" | |
| H= SIDES | 6" | 8" | 6" | 8" | 6" | | 6" | 8" | 6" | |
| I= BACK | 6" | 8" | 6" | 8" | 6" | | 6" | 8" | 6" | |
| ALCOVE - TO COMBUSTIBLE | | | | | | | | | | |
| J= MINIMUM WIDTH | 59 3/8" | | 54" | | 49 3/8" | | 54" | | 62" | |
| K= MAXIMUM DEPTH | 48" | | 48" | | 48" | | 48" | | 48" | |
| L= MINIMUM HEIGHT | 84" | | 84" | | 84" | | 84" | | 84" | |

CLEARANCES TO UNPROTECTED COMBUSTIBLES

USE THESE ILLUSTRATIONS IN CONJUNCTION WITH THE INFORMATION UNDER THE "CLEARANCE" & "ALCOVE" HEADINGS ABOVE.

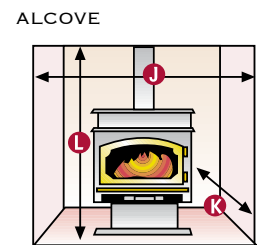
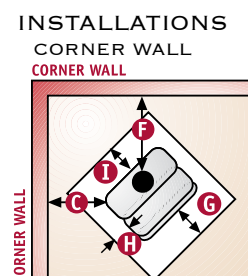
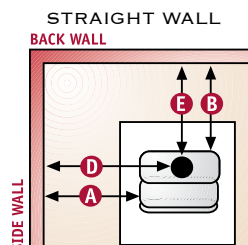

*HEATING CAPACITY MAY VARY DEPENDING ON DEGREE OF HOME INSULATION, FLOOR PLAN AND AMBIENT TEMPERATURE ZONE OF THE AREA IN WHICH YOU LIVE.



WHY BUY A LOPI FIREPLACE INSERT?



TURN YOUR OLD INEFFICIENT FIREPLACE INTO A GREAT HEAT SOURCE

An open fireplace sends up to 80 percent of the fire's heat up the chimney and depletes warm air from surrounding rooms. A Lopi fireplace insert is more than five times as efficient as an open fireplace and features a built-in convection chamber to circulate and distribute warm air throughout the home. You can convert your wasteful masonry or metal fireplace into a super-efficient hearth system that can heat your entire home for a fraction of what you'd pay for gas, electricity or oil.

USE ZONE HEATING TO SAVE ON YOUR HEATING BILL

Installing a Lopi wood insert into your inefficient fireplace is a great way to incorporate a beautiful heating appliance into your home. Typically the fireplace is located in the heart of your home, so adding a Lopi insert is ideal for heating the area of the home you use the most. The term for heating your living area, rather than the entire home is called 'Zone Heating'. By using the optional convection fan (standard in the Declaration and Freedom Bay) you can quickly heat the area where you spend the most time. So instead of turning up your furnace and trying to heat your entire home, use your Lopi insert to heat where you need it most. Studies indicate that zone heating can provide energy savings of 20-40 percent.*

*ACEEE 1990 Study on Energy Efficiency in Buildings Proceedings Volume 9.

RELIABILITY

Power outages can last for days. A Lopi wood burning insert keeps you warm and self sufficient while your neighbors are in the dark. The extended hearth models Revere and Freedom offer you a great radiant cooktop surface that allows you to cook and warm food or beverages.

EFFICIENT AND EASY TO USE

Lopi inserts distribute heat evenly with a five-sided convection chamber - a standard feature with us but expensive or unavailable in other brands. They are also easy to use with a single control to regulate heat output and most feature a bypass dampers for smokeless startup and reloading.

STYLES FOR EVERY HOME

Lopi has a wide range of sizes and options to fit your heating needs and living environment. You can mount your insert flush to the hearth or extend it for extra radiant heating. Blowers are available for enhanced heat flow and you can pick your own doors, etched glass options and even different paint finishes. Finish your insert with the panel set that is used to cover the outside opening of the fireplace or cut it down for a cleaner looking inside fit. Ask your professional Lopi hearth dealer for details.





REPUBLIC 1250

I N S E R T

Available in
CANADA



11



Shown with black cast door, optional fan and 10" panels.

Now experience the performance and quality you've come to expect in Lopi wood stoves in two mid-priced economy fireplace inserts. Without compromising construction or function, Lopi has managed to produce a wood insert line that's designed to be affordable, good looking and just plain heats.

Republic wood burning inserts are clean, green, efficient and come in two models - The 1250i for smaller homes or zonal heating needs and the 1750i for mid-sized homes or zonal heating specific areas of large homes. Comes with a 5 year Real World Warranty.

Options: Convection Fan and Firescreen.

| Emissions | Heating Capacity | Heat Output | Maximum Burn Time | Firebox Size | Maximum Log Size | Weight | Construction | Efficiency |
|--------------------|----------------------|------------------------------|-------------------|----------------|------------------|----------|---------------------------|-------------|
| 4.4 Grams Per Hour | 600 to 1,200 Sq. Ft. | Cord Wood 66,800 BTUs/Hr. | Up To 8 Hours | 1.6 Cubic Foot | Up To 18" | 243 lbs. | 1/4" to 3/16" Steel Plate | Up To 79.6% |

REPUBLIC 1750

I N S E R T

COOKTOP SURFACE



Available in
CANADA



12

Shown with standard black door, optional fan and 10" panels. Keep combustibles 36" from front of stove.

With a Republic wood burning insert you can turn your old, inefficient open masonry or metal (ZC) fireplace into a great heat source for your home. A Republic insert is more than five times as efficient as an open fireplace and features a built-in convection chamber to circulate and distribute heat throughout your home. The model 1750i even features a bypass damper that allows quick and easy fire start-up. Republic inserts will provide your family with reliable heat source - even during power outages. Comes with a 5 year Real World Warranty.

Options: Convection Fan and Firescreen.

| Emissions | Heating Capacity | Heat Output | Maximum Burn Time | Firebox Size | Maximum Log Size | Weight | Construction | Efficiency |
|--------------------|------------------------|------------------------------|-------------------|----------------|------------------|----------|----------------------------|-------------|
| 1.9 Grams Per Hour | 1,200 to 2,000 Sq. Ft. | Cord Wood 72,400 BTUs/Hr. | Up To 10 Hours | 2.2 Cubic Foot | Up To 18" | 430 lbs. | 5/16" to 3/16" Steel Plate | Up To 78.8% |



DECLARATION I N S E R T

13



Shown with black painted Wilmington face and 8" surround panels

Declare your home free from high heating bills this season with the Declaration™ fireplace insert. The first insert on the market that is truly flush to the fireplace. Enjoy high efficiency along with sleek good looks. The advanced combustion system provides fires that burn longer and more efficiently with less wood. Though flush to the fireplace, the Declaration is designed to really heat. The Declaration comes standard with efficient twin 90 CFM convection fans designed to circulate lasting heat reaching up to 2,000 square feet. Large double doors stay clean longer with our air wash system and show off the flames for an open-fireplace experience. You can choose the optional Insert Hard-Wiring Kit for a clean, cordless hearth.

| Emissions | Heating Capacity | Heat Output | Maximum Burn Time | Firebox Size | Maximum Log Size | Weight | Construction | Efficiency |
|--------------------|------------------------|------------------------------|-------------------|----------------|------------------|----------|---------------------------|-------------|
| 4.1 Grams Per Hour | 1,200 to 2,000 Sq. Ft. | Cord Wood 73,300 BTUs/Hr. | 12 Hours | 2.9 Cubic Foot | 24" | 460 lbs. | 5/16" to 1/4" Steel Plate | Up To 76.9% |



DECLARATION FACE AND GRILL SELECTION

The Declaration wood burning fireplace insert has two beautiful faces to choose from - the Wilmington black or the Wilmington brushed nickel plated. Brushed nickel plated Arabesque Grills are available to change the look even further. Switch between standard vertical grills which ship with the face and the optional antique nickel Arabesque Grills any time you'd like for different looks depending on your mood!

FACE OPTION 1



Black Wilmington face comes standard with vertical bar grills and black doors



Or order the optional Brushed Nickel Arabesque Grills



Black Wilmington face with Arabesque grills installed

FACE OPTION 2



Brushed Nickel Wilmington face comes standard with pewter vertical bar grills and black doors



Or order the optional Brushed Nickel Arabesque Grills



Brushed Nickel Wilmington face with Arabesque grills installed

CORDLESS HEARTH OPTION

Don't want a power cord running across the hearth? Lopi offers the option of adding the Insert Wiring Kit that allows you the ability to hard-wire the insert convection fan to an electrical junction box mounted within the fireplace. We recommend the Insert Wiring Kit be installed by a licensed electrician before the installation of the insert.

PANEL EXTENSION TRIM OPTION

These surround panels include trim that protrudes an additional 1-1/2". This re-positions the flush wood insert an additional 1-1/2" onto the hearth, easing installation into narrower depth fireplaces.



ANSWER

I N S E R T

15



Shown with the optional pewter door and ash-lip trim, optional convection fan and 8" surround panels.

The Answer™ is a terrific way to heat a secluded room or small home. It conserves space by mounting flush into your existing masonry or zero clearance fireplace. Yet it still offers advanced features like a five-sided convection chamber to distribute warm air evenly and a single air control for easy regulation of burn and heat output. The Answer's door opening is 2 inches taller than most other small inserts, so you can load it with larger pieces of wood. The Answer has the largest firebox available in a small insert, so it offers longer burn times and gives you more time to enjoy watching the flames between fuel loadings.

Options: Door finishes in Black, Brass or Pewter, Finish Panels, Convection Fan, Etched Glass and Firescreen.

| Emissions | Heating Capacity | Heat Output | Maximum Burn Time | Firebox Size | Maximum Log Size | Weight | Construction | Efficiency |
|--------------------|----------------------|------------------------------|-------------------|----------------|------------------|----------|----------------------------|-------------|
| 4.4 Grams Per Hour | 750 to 1,200 Sq. Ft. | Cord Wood 66,800 BTUs/Hr. | 8 Hours | 1.6 Cubic Foot | 18" | 285 lbs. | 5/16" to 3/16" Steel Plate | Up To 79.6% |

REVERE I N S E R T



COOKTOP SURFACE



16

Shown with the optional pewter door and customized with metallic brown paint finish, 8" surround panels and convection fan.

An excellent primary heat source for medium-sized homes, the Revere™ is truly in a class of its own. Its 10" x 24" radiant cooking surface is bigger than any other medium insert, and is also has the largest and cleanest burning firebox of any mid-sized insert. The Revere can take logs crosswise or lengthwise for greater capacity and longer burn times. The Revere is the only insert of its size to use a by-pass damper for easy fire startup and smoke-free reloading. The Revere is the largest wood burning insert approved for zero clearance fireplace installations.

Options: Door finishes in Black, Brass or Pewter, Finish Panels, Convection Fan, Etched Glass and Firescreen.

| Emissions | Heating Capacity | Heat Output | Maximum Burn Time | Firebox Size | Maximum Log Size | Weight | Construction | Efficiency |
|--------------------|------------------------|------------------------------|-------------------|----------------|------------------|----------|----------------------------|-------------|
| 1.9 Grams Per Hour | 1,200 to 2,000 Sq. Ft. | Cord Wood 72,400 BTUs/Hr. | 10 Hours | 2.2 Cubic Foot | 18" | 380 lbs. | 5/16" to 3/16" Steel Plate | Up To 78.8% |



FREEDOM

I N S E R T

Available in
CANADA



17



Shown with optional solid brass door, 8" rectangular panels and convection fan.



The extended application provides a great cooktop surface.

By delivering a remarkable 76.9% efficiency rating, the Freedom™ reigns as the most efficient large insert on the market. It is the only insert of its size that can either mount flush (a good way to go if used as a room heater or for backup heat) or extended 7 inches onto the hearth (which provides an additional radiant heat and a great cooking surface). The Freedom insert is suitable for most existing masonry fireplaces because the firebox is tapered to fit the widest possible range of fireplace openings. The Freedom can also take a 24 inch log, making overnight burns easier than ever before.

Options: Door and Trim Kit in Black, Brass or Pewter finishes, Etched Glass, Firescreen and Arched & Rectangular Panels.

| Emissions | Heating Capacity | Heat Output | Maximum Burn Time | Firebox Size | Maximum Log Size | Weight | Construction | Efficiency |
|--------------------|---|------------------------------|-------------------|----------------|-----------------------|----------|-------------------------------|----------------|
| 3.2 Grams Per Hour | Extended Model 1,200 to 2,250 Sq. Ft. Flush Model 1,200 to 2,000 Sq. Ft. | Cord Wood 73,300 BTUs/Hr. | 12 Hours | 2.9 Cubic Foot | 24" Front 18" Back | 455 lbs. | 5/16" to 3/16" Steel Plate | Up To 76.9% |

FREEDOM BAY

I N S E R T



Shown with optional solid brass door, customized blue metallic paint finish and 8" surround panels.

The Freedom Bay™ is proof that beauty and function really can be engineered to go hand in hand. At an emission rate of only 2.6 grams per hour, it is the cleanest burning large insert ever tested and approved by the EPA. Framed by hand-polished solid brass, the bay “windows” are actually side convection chambers that allow air to circulate around the huge firebox and return to the room heated. Because it’s flush mounted, the Freedom Bay includes a quiet, yet powerful blower (standard) to produce superior air flow. The Freedom Bay also comes with the choice of a solid brass, black painted or pewter door and trim, making this insert our most distinctive and elegant heater for larger homes.

Options: Door and Trim Kit in Black, Brass or Pewter finishes, Etched Glass, Firescreen and Arched & Rectangular Panels.

| Emissions | Heating Capacity | Heat Output | Maximum Burn Time | Firebox Size | Maximum Log Size | Weight | Construction | Efficiency |
|--------------------|------------------------|------------------------------|-------------------|----------------|------------------|----------|----------------------------|-------------|
| 2.6 Grams Per Hour | 1,200 to 2,250 Sq. Ft. | Cord Wood 74,300 BTUs/Hr. | 12 Hours | 3.1 Cubic Foot | 24" | 470 lbs. | 5/16" to 3/16" Steel Plate | Up To 76.9% |



LOPI WOOD INSERTS

19



REPUBLIC 1250i



REPUBLIC 1750i



ANSWER
ZERO CLEARANCE APPROVED



REVERE
ZERO CLEARANCE APPROVED



DECLARATION



FREEDOM



FREEDOM BAY

| SPECIFICATIONS | SMALL | | MEDIUM | | LARGE | | | |
|--|----------------------------|----------------------|------------------------|---------------------------------|--|----------------------------|-------------------------------|-----------------------|
| | WIDTH | 23 7/8" | 24 1/4" | 28 7/8" | 29 1/4" | 29 1/4" | 43 3/4" | |
| HEIGHT | 20 3/4" | 19 3/4" | 21 1/2" | 21 3/4" | 21 3/4" | 21 3/4" | | |
| DEPTH (OVERALL) | 16 1/4" | 23 1/8" | 21 3/4" | 20 1/2" | 20 1/2" | 20 1/2" | | |
| DEPTH ON HEARTH | 3" | 10" | 1 1/4" | 7" (EXT) - 1 3/8" (FLUSH) | 7" (EXT) - 1 3/8" (FLUSH) | 4 3/4" | | |
| DEPTH INTO FIREPLACE | 13 1/2" | 13 1/8" | 20 1/2" | 13 1/2" (EXT) - 18 7/8" (FLUSH) | 13 1/2" (EXT) - 18 7/8" (FLUSH) | 15 3/4" | | |
| FLUE SIZE | 6" | 6" | 6" | 6" | 6" | 6" | | |
| CONSTRUCTION (PLATE STEEL) | 5/16" TO 3/16" | 5/16" TO 3/16" | 5/16" TO 1/4" | 5/16" TO 3/16" | 5/16" TO 3/16" | 5/16" TO 3/16" | | |
| WEIGHT (BODY) | 300 LBS. | 380 LBS. | 450 LBS. | 455 LBS. | 455 LBS. | 470 LBS. | | |
| PERFORMANCE | EMISSIONS 4.4 GRAMS/HR. | | 1.9 GRAMS/HR. | | 4.1 GRAMS/HR. | | | |
| HEATING CAPACITY | 750 TO 1,200 Sq. Ft. | | 1,200 TO 2,000 Sq. Ft. | | 1,200 TO 2,000 Sq. Ft. (FL.) 1,200 TO 2,250 Sq. Ft. (EXT.) | | | |
| HEAT OUTPUT (CORD WOOD) | 66,800 BTU'S/HR. | | 72,400 BTU'S/HR. | | 73,300 BTU'S/HR. | | | |
| EFFICIENCY (DEQ) | UP TO 79.6% | | UP TO 78.8% | | UP TO 76.9% | | | |
| MAXIMUM BURN TIME | UP TO 8 HOURS | | UP TO 10 HOURS | | UP TO 12 HOURS | | | |
| FIREBOX SIZE | 1.6 CUBIC FT. | | 2.2 CUBIC FT. | | 2.9 CUBIC FT. | | | |
| MAXIMUM LOG SIZE | 18" | | 18" | | 24" | | | |
| CLEARANCES | MASONRY FIREPLACE | METAL (ZC) FIREPLACE | MASONRY FIREPLACE | METAL (ZC) FIREPLACE | MASONRY FIREPLACE | MASONRY FIREPLACE EXTENDED | MASONRY FIREPLACE W/FLUSH KIT | MASONRY FIREPLACE |
| A= FIREBOX TO MANTEL = WITH MANTEL SHIELD | 15 1/2" | 24" | 30 1/2" | 24" | 41 1/2" (MEASURED FROM FLOOR) | 32" | 20" | 32" |
| B= FIREBOX TO TOP FACING = WITH MANTEL SHIELD | 12" | 12" | 28 1/2" | 12" | 39" (MEASURED FROM FLOOR) | 19" | N/A | 19" |
| C= FIREBOX SIDE TO SIDE FACING | 9 1/2" | 12" | 13" | 12" | 9" | 13 1/2" | 13 1/2" | 13 1/2" |
| D= FIREBOX SIDE TO SIDE WALL | 13" | 30" | 15" | 30" | 9" | 15" | 15" | 15" |
| FIREPLACE SIZING | MASONRY FIREPLACE | METAL (ZC) FIREPLACE | MASONRY FIREPLACE | METAL (ZC) FIREPLACE | MASONRY FIREPLACE | MASONRY FIREPLACE EXTENDED | MASONRY FIREPLACE W/FLUSH KIT | MASONRY FIREPLACE |
| E= MINIMUM DEPTH | 13 1/2" | 14 1/2" | 13 1/8" | 14 1/8" | 20 1/2" | 13 1/2" | 18 7/8" | 15 3/4" |
| F= MINIMUM FRONT WIDTH | 23 5/8" | 25 5/8" | 24 1/4" | 26 1/4" | 30 7/8" | 29 1/4" | 29 1/4" | 29 1/4" |
| G= MINIMUM BACK WIDTH | 23 5/8" | 25 5/8" | 21 5/8" | 23 5/8" | 21 1/4" | 21 1/4" | 21 1/4" | 29 1/4" |
| H= MINIMUM HEIGHT | 20 3/4" | 20 3/4" | 19 3/4" | 19 3/4" | 21 1/2" | 21 3/4" | 21 3/4" | 21 3/4" |
| PANEL SIZES | RECTANGULAR PANELS LISTED. | | | | ASK YOUR DEALER FOR SIZING ON ARCHED PANELS. (FREEDOM ONLY) | | | |
| 8" X 8" | 28 1/4" H X 40 1/8" W | | 27 5/8" H X 40 5/8" W | | 29 1/2" H X 45 1/2" W | | | 29 1/2" H X 45 5/8" W |
| 10" X 10" | 30 1/4" H X 44 1/8" W | | 29 5/8" H X 44 5/8" W | | 31 1/2" H X 49 1/2" W | | | 31 1/2" H X 49 5/8" W |
| 12" X 12" | N/A | | 31 5/8" H X 48 5/8" W | | 33 1/2" H X 53 1/2" W | | | 33 1/2" H X 53 5/8" W |

CLEARANCES TO UNPROTECTED COMBUSTIBLES:

USE THESE ILLUSTRATIONS IN CONJUNCTION WITH THE INFORMATION UNDER THE "CLEARANCE" & "ALCOVE" HEADINGS ABOVE.

ALL INSERTS MUST HAVE A NON-COMBUSTIBLE HEARTH PAD THAT EXTENDS A MINIMUM OF 16" IN FRONT OF THE INSERT AND 8" TO THE SIDES.

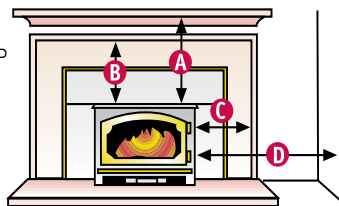

SIZING YOUR FIREPLACE FOR AN INSERT:

USE THESE ILLUSTRATIONS IN CONJUNCTION WITH THE INFORMATION UNDER THE "FIREPLACE SIZING" HEADINGS ABOVE.

PLEASE USE THE PROVIDED CHART ON THE RIGHT TO MARK DOWN YOUR FIREPLACE DIMENSIONS. THIS WILL ASSIST YOU IN DETERMINING THE RIGHT LOPI INSERT FOR YOUR FIREPLACE.

APPROVED ZC FIREPLACES:

THE ANSWER AND REVERE INSERTS ARE APPROVED FOR MARCO, MAJESTIC, HEATILATOR, SUPERIOR, PREWAY AND TEMPCO ZERO CLEARANCE FIREPLACES. SEE THE OWNER'S MANUAL FOR DETAILS.

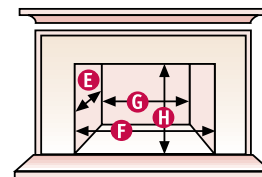

YOUR FIREPLACE MEASUREMENTS

- E. _____
- DEPTH
- F. _____
- FRONT WIDTH
- G. _____
- BACK WIDTH
- H. _____
- HEIGHT

LOPI STOVE & INSERT OPTIONS & ACCESSORIES

THESE OPTIONS NOT AVAILABLE FOR THE DECLARATION WOOD INSERT



DOORS

CHOOSE FROM THREE DOOR FINISHES TO BLEND OR ACCENT YOUR STOVE AND ROOM DECOR. NOT AVAILABLE ON REPUBLIC.

- SOLID BRASS, BLACK PAINTED, PEWTER PLATED



ELK ETCHED GLASS

BRING THE GREAT OUTDOORS INSIDE WITH THE DECORATIVE ELK ETCHED GLASS DESIGN. NOT AVAILABLE FOR THE REPUBLIC WOOD STOVES.



FIRESCREEN

BURN YOUR STOVE OR INSERT WITH THE DOOR OPEN TO ENJOY THE CRACKLING SOUND OF A THE FIRE.



PEDESTALS

AVAILABLE FOR THE REPUBLIC, ANSWER, ENDEAVOUR AND LIBERTY FREESTANDING STOVES. PEDESTALS ALLOW FOR A CLEAN INSTALLATION OF OUTSIDE COMBUSTION THROUGH THE BACK OR BOTTOM OF THE PEDESTAL.



SCULPTURED
PEWTER FINISH



SCULPTURED
BLACK STEEL



CAST
BRASS



CAST
BLACK

FOUR DECORATIVE LEG CHOICES

CAN BLEND OR CONTRAST WITH YOUR STOVE DEPENDING ON THE STYLE AND FINISH YOU SELECT.



STOVE FAN

INSTALLS IN BACK OF UNIT.

CONVECTION FANS

HIGH ON POWER BUT LOW ON NOISE. THEY HELP CIRCULATE HEAT BY MOVING UP TO 160 CUBIC FEET OF AIR PER MINUTE.



INSERT FAN

INSTALLS IN FRONT OF UNIT.

SHOWN INSTALLED ON PAGES 15 & 16.

PANELS

FIREPLACE INSERT PANELS COME IN THREE SIZES, 8", 10" AND 12" TO FIT A WIDE VARIETY OF FIREPLACE OPENINGS. ALL PANELS HAVE THE FLEXIBILITY TO BE CUSTOM CUT FOR AN INSIDE-FIT TO THE FIREPLACE OPENING. ARCHED PANELS ARE ALSO AVAILABLE FOR THE FREEDOM AND FREEDOM BAY INSERTS.



PAINT

LOPI STOVES AND INSERTS CAN BE PAINTED IN A VARIETY OF COLORS TO FIT ANY DÉCOR (ASK YOUR DEALER FOR CUSTOM COLOR CHOICES).





HOW A LOPI WOOD STOVE WORKS

- 1 Pre-heated air wash cleans the glass like a self-cleaning oven; (1A) a steady stream of fresh air enters the stove, gets hot as it is drawn up the heated internal air chamber, and (1B) then travels through a screened airwash which diffuses and evenly distributes air across the glass keeping smoke and ash particles away.
- 2 Pre-heated secondary combustion air (2A) is delivered to the stainless steel secondary combustion tubes (2B) which introduces oxygen to the firebox and promotes re-burn of most of the smoke and gases that would otherwise line your flue as creosote and exit your chimney as smoke.
- 3 The heavy-duty masonry baffle holds and radiates heat back into the firebox for more efficient and complete combustion.
- 4 An optional blower is available to speed up the circulation of convective heat throughout your home. A blower is ideal for quicker more efficient heating, or for larger a home with high ceilings or a home with an open floorplan.

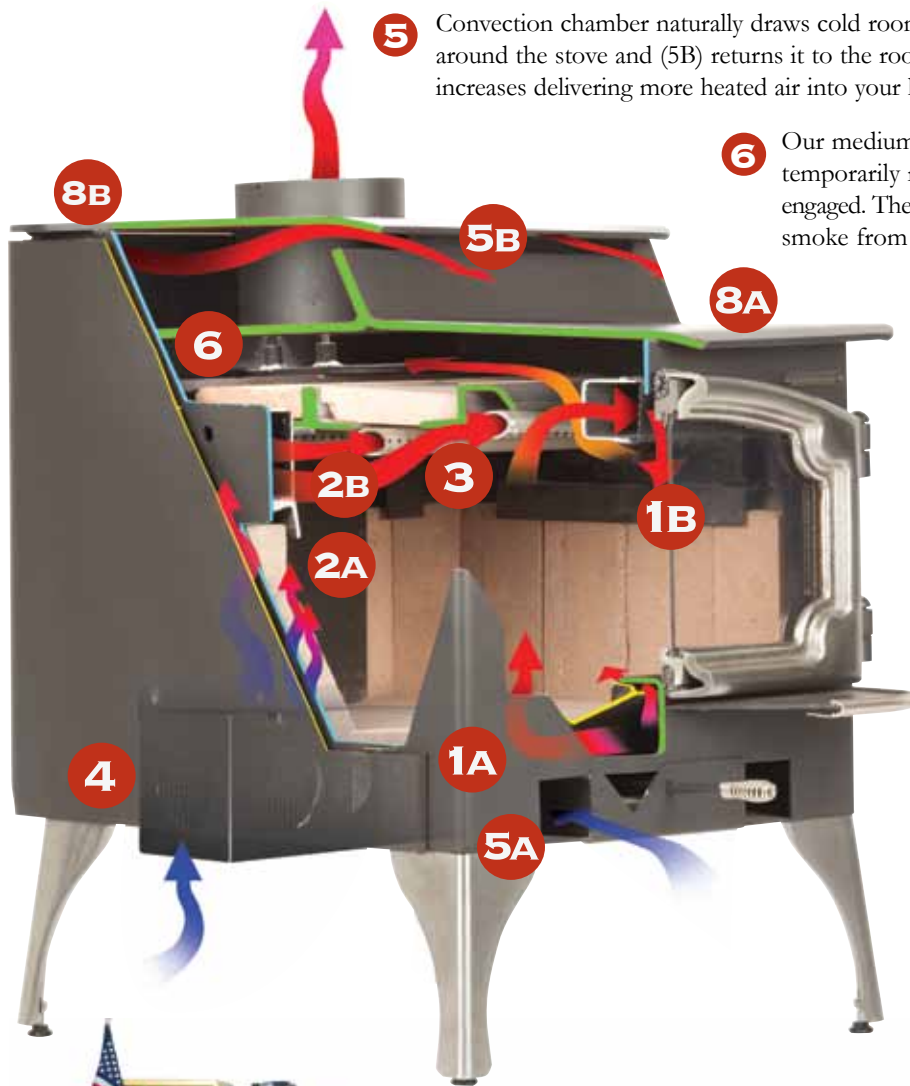

5 Convection chamber naturally draws cold room air (5A) in at the bottom of the unit, circulates it around the stove and (5B) returns it to the room heated. As the stove heats up air flow actually increases delivering more heated air into your home.

6 Our medium and large units feature By-Pass dampers which temporarily re-routes smoke behind the masonry baffle when engaged. The by-pass assists faster fire start-up as well as preventing smoke from escaping through the door when loading wood.

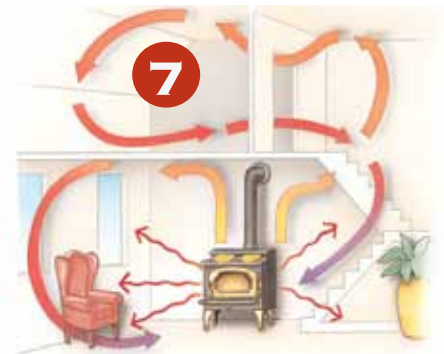

7 Lopi stoves feature a large capacity convection chamber which enhances the heat transfer by gently circulating heated air to adjoining rooms, while still offering radiant heat that warms the room and the objects in it.

8 Our wood stoves also provide a great cooktop surface. The cooktop surface can be used to warm soup, heat up hot cocoa or for scented potpourri. Our medium and large stoves give you both a cooktop (8A) and warming (8B) surface, so not only will your stove heat your home during a power outage, you can also cook on it





WE BUILD THE FINEST WOOD STOVES ON THE PLANET

No other wood burning stove can surpass Lopi's performance or quality. It takes the best engineers and craftsmen to make the best stoves, and we've got them. Your new Lopi stove features true unibody construction and the most durable door on the market. The Lopi door is held in place with cold-rolled steel punched through the firebox and welded on the inside to hold the door permanently straight. The hinge pins that hold the door are 5/8" bridge rivets. Your stove also has a six-inch, seamless, heavy-duty steel flue collar and heavy gauge 5/16" & 3/16" steel construction. When you buy a Lopi, you're buying the finest. We guarantee it.



The solid brass door will last for life (unlike the micro-thin gold plating common to many other stove brands). Pewter doors are available on all stoves and inserts.



Lopi uses real kiln-fired, refractory firebrick in the firebox and baffle. This is the same material used to line commercial boilers and furnaces. This brick is heavy and made to last.



Our single air control is easier to fine tune to your heating needs by regulating both primary and secondary air to the stove. The control is spring loaded to insure an engineered seal to the bottom of the firebox. The result is a sealed air-control which will not allow any additional air into the firebox.



Cast iron frame glass retainer insures a permanent air-tight seal around the glass. The cast iron frame fits an inch deep inside the door, so the door will never warp or flex. The frame also protects the glass gasketing from direct contact with the fire.

7-YEAR "REAL WORLD" WARRANTY (5 YEARS ON THE REPUBLIC STOVES & INSERTS)

Our 7-Year Warranty offers more protection on key components than the so-called "Lifetime" warranties of our competitors. We cover all electrical (blowers) for 2 years, all parts (with labor) for 5 years, and parts for an additional 2 years. That's because Lopi builds stoves to last a lifetime. We'll stand behind the quality and performance of our products year after year because that's the way we do business --and you don't have to read the fine print for your peace of mind.

